

Dell OptiPlex 3060 Tower

Setup and specifications guide



Notes, cautions, and warnings

 | **NOTE:** A NOTE indicates important information that helps you make better use of your product.

 | **CAUTION:** A CAUTION indicates either potential damage to hardware or loss of data and tells you how to avoid the problem.

 | **WARNING:** A WARNING indicates a potential for property damage, personal injury, or death.

© 2019 Dell Inc. or its subsidiaries. All rights reserved. Dell, EMC, and other trademarks are trademarks of Dell Inc. or its subsidiaries. Other trademarks may be trademarks of their respective owners.

Contents

1 Set up your computer	5
2 Chassis	9
Front view.....	9
Back view.....	10
3 System specifications	11
Processor.....	11
Memory.....	12
Storage.....	12
Chipset.....	13
Storage combinations.....	13
Audio.....	13
Video.....	14
Communications.....	15
Ports and connectors.....	15
System board connectors.....	15
Power supply.....	16
Physical system dimensions.....	16
Security.....	17
Environmental.....	17
4 System setup	18
System setup.....	18
General options.....	19
System information.....	19
Video screen options.....	21
Security.....	21
Secure boot options.....	22
Intel Software Guard Extensions options.....	23
Performance.....	23
Power management.....	24
Post behavior.....	25
Virtualization support.....	26
Wireless options.....	26
Maintenance.....	26
System logs.....	27
Advanced configuration.....	27
SupportAssist System Resolution.....	27
5 Software	28
Supported operating systems.....	28
Downloading drivers.....	28

Network adapter drivers.....	29
Audio drivers.....	29
Display adapter.....	29
Security drivers.....	29
Storage controller.....	29
System device drivers.....	30
Other device drivers.....	31
6 Getting help.....	33
Contacting Dell.....	33

Set up your computer

- 1 Connect the keyboard and mouse.

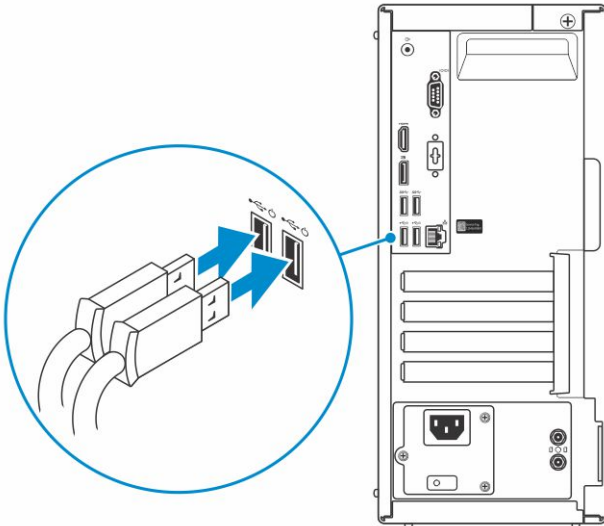

- 2 Connect to your network using a cable, or connect to a wireless network.

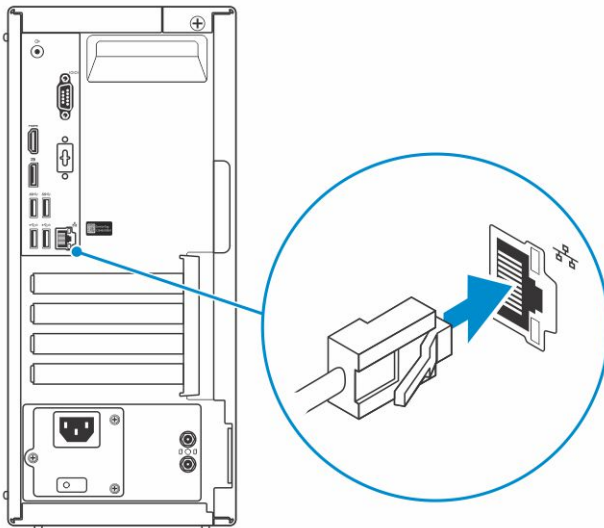

- 3 Connect the display.

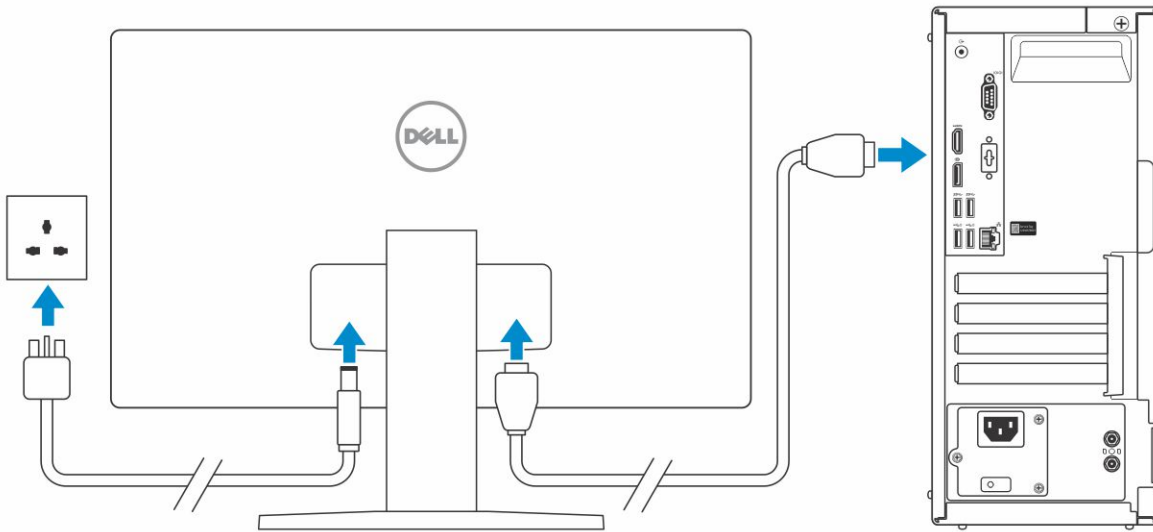

NOTE: If you ordered your computer with a discrete graphics card, the HDMI and the display ports on the back panel of your computer are covered. Connect the display to the discrete graphics card.

4 Connect the power cable.

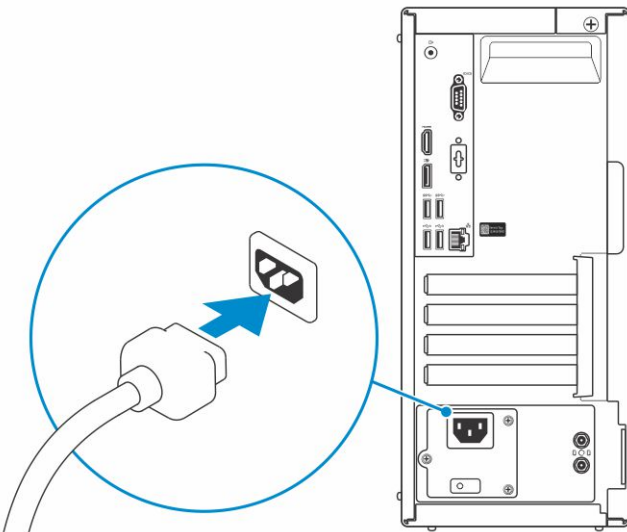

5 Press the power button.

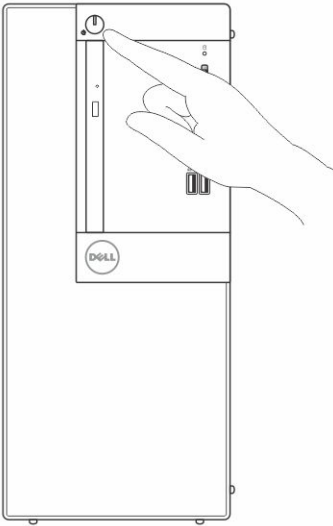

- 6 Follow the instructions on the screen to finish Windows setup:
 - a Connect to a network.

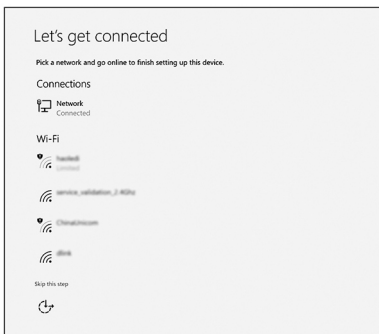



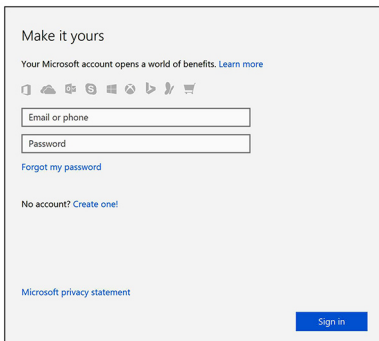

- b Sign-in to your Microsoft account or create a new account.

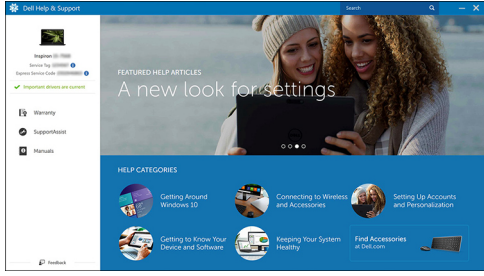

- 7 Locate Dell apps.

Table 1. Locate Dell apps

Dell Apps	Description
	Register your computer Dell Help & Support
	
	SupportAssist — Check and update your computer

Chassis

This chapter illustrates the multiple chassis views along with the ports and connectors and also explains the FN hot key combinations.

Topics:

- [Front view](#)
- [Back view](#)

Front view

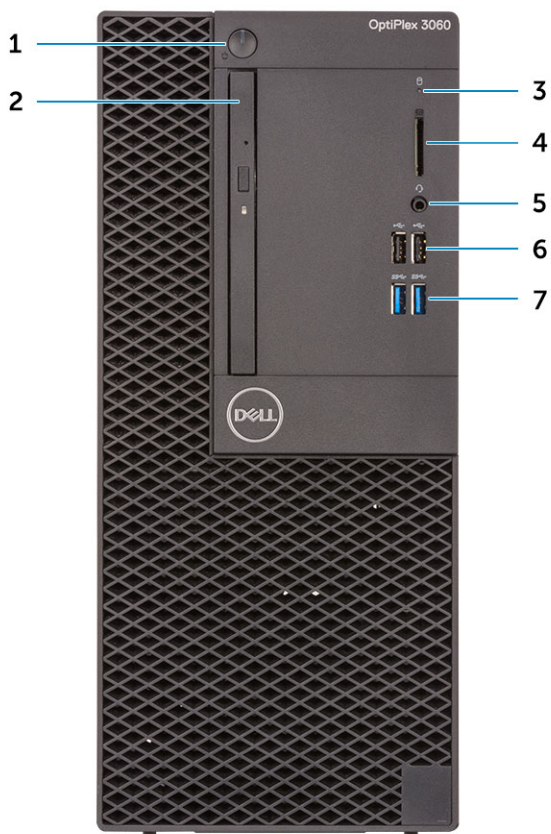

- | | | | |
|---|---|---|-------------------------------|
| 1 | Power button and power light/diagnostic LED | 2 | Optical drive (optional) |
| 3 | Hard drive activity light | 4 | Memory card reader (optional) |
| 5 | Headset port/Universal audio jack port | 6 | USB 2.0 ports (2) |
| 7 | USB 3.1 Gen 1 ports (2) | | |

Back view

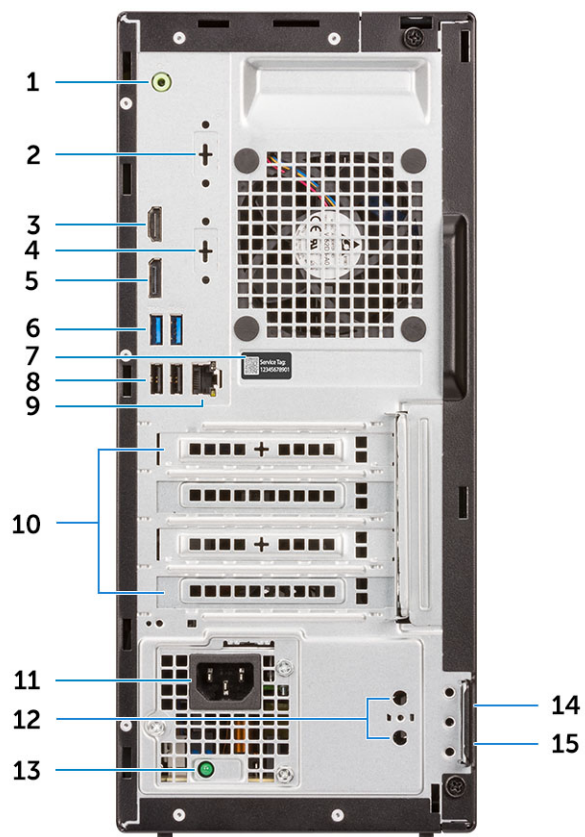

- | | | | |
|----|-------------------------------|----|--|
| 1 | Line-out port | 2 | Serial Port (optional) |
| 3 | HDMI port | 4 | DP/HDMI2.0b/VGA port (optional) |
| 5 | DisplayPort | 6 | USB 3.1 Gen 1 ports (2) |
| 7 | Service tag | 8 | USB 2.0 ports (supports SmartPower On) |
| 9 | Network port | 10 | Expansion card slots (4) |
| 11 | Power connector port | 12 | External antenna connectors (2) (optional) |
| 13 | Power supply diagnostic light | 14 | Kensington security cable slot |
| 15 | Padlock ring | | |

System specifications

NOTE: Offerings may vary by region. The following specifications are only those required by law to ship with your computer. For more information about the configuration of your computer, go to Help and Support in your Windows operating system and select the option to view information about your computer.

Topics:

- Processor
- Memory
- Storage
- Chipset
- Storage combinations
- Audio
- Video
- Communications
- Ports and connectors
- System board connectors
- Power supply
- Physical system dimensions
- Security
- Environmental

Processor

Global Standard Products (GSP) are a subset of Dell's relationship products that are managed for availability and synchronized transitions on a worldwide basis. They ensure the same platform is available for purchase globally. This allows customers to reduce the number of configurations managed on a worldwide basis, thereby reducing their costs. They also enable companies to implement global IT standards by locking in specific product configurations worldwide. The following GSP processors identified below will be made available to Dell customers.

NOTE: Processor numbers are not a measure of performance. Processor availability is subject to change and may vary by region/country.

Table 2. Processor specifications

Type	UMA Graphics
Intel Celeron G4900 (2 Cores/2 MB cache/2 Threads/up to 3.1 GHz/65 W); supports Windows 10/Linux	Intel UHD Graphics 610 with shared graphics memory
Intel Pentium Gold G5400 (2 Cores/4 MB cache/4 Threads/3.7 GHz/65 W); supports Windows 10/Linux	Intel UHD Graphics 610 with shared graphics memory
Intel Pentium Gold G5500 (2 Cores/4 MB cache/4 Threads/3.8 GHz/65 W); supports Windows 10/Linux	Intel Ultra HD Graphics 630
Intel Core i3-8100 (4 Cores/6 MB cache/4 Threads/3.6 GHz/65 W); supports Windows 10/Linux	Intel HD Graphics 630

Type	UMA Graphics
Intel Core i3-8300 (4 Cores/8 MB cache/4 Threads/3.7 GHz/65 W); supports Windows 10/Linux	Intel HD Graphics 630
Intel Core i5-8400 (6 Cores/9 MB cache/6 Threads/up to 4.0 GHz/65 W); supports Windows 10/Linux	Intel HD Graphics 630
Intel Core i5-8500 (6 Cores/9 MB cache/6 Threads/up to 4.1 GHz/65 W); supports Windows 10/Linux	Intel HD Graphics 630
Intel Core i7-8700 (6 Cores/12 MB cache/12 Threads/up to 4.6 GHz/65 W); supports Windows 10/Linux	Intel HD Graphics 630

Memory

Table 3. Memory specifications

Features	Specifications
Minimum memory configuration	4 GB
Maximum memory configuration	32 GB
Number of slots	2 UDIMM
Maximum memory supported per slot	16 GB
Memory options	<ul style="list-style-type: none"> 4 GB - 1 x 4 GB 8 GB - 1 x 8 GB 8 GB - 2 x 4 GB 16 GB - 2 x 8 GB 16 GB - 1 x 16 GB 32 GB - 2 x 16 GB
Type	DDR4 SDRAM Non-ECC memory
Speed	<ul style="list-style-type: none"> 2666 MHz 2400 MHz on Celeron, Pentium, and i3 processor

Storage

Table 4. Storage specifications

Type	Form factor	Interface	Capacity
One Solid-State Drive (SSD)	M.2 2230 or 2280	<ul style="list-style-type: none"> SATA AHCI, Up to 6 Gbps PCIe 2 x 4 Nvme, Up to 32 Gbps SATA C20 SED SSD 	<ul style="list-style-type: none"> Up to 512 GB Up to 1 TB Up to 512 GB
One 3.5 inch		SATA 3.0, Up to 6 Gbps	Up to 2 TB, upto 7200 RPM
Two 2.5 inch Hard-Disk Drive (HDD)		SATA AHCI, Up to 6 Gbps	Up to 2 TB, upto 7200 RPM

Type	Form factor	Interface	Capacity
One 2.5 inch Self-encrypting drive Hard-Disk Drive (SED HDD)		SATA AHCI, Up to 6 Gbps	Up to 512 GB, upto 7200 RPM

Chipset

Table 5. Chipset specifications

Features	Specifications
Type	Intel H370
Non-volatile memory on chipset	Yes
BIOS configuration SPI (Serial Peripheral Interface)	256 Mbit (32 MB) located at SPI_FLASH on chipset
Trusted Platform Module (TPM) 2.0 Security Device (Discrete TPM Enabled)	24 KB located at TPM 2.0 on chipset
Firmware-TPM (Discrete TPM disabled)	By default the Platform Trust Technology feature is visible to the OS
NIC EEPROM	LOM configuration contained within LOM e-fuse – no dedicated LOM EEPROM

Storage combinations

Table 6. Storage combinations

Primary/Boot drive	Specifications
1 x 2.5 inch HDD with M.2 Optane	2.5 500 GB 7200 rpm HDD + Intel Optane Memory
1 x 2.5 inch HDD with M.2 Optane	2.5 1 TB 7200 rpm HDD + Intel Optane Memory
1 x 2.5 inch HDD with M.2 Optane	2.5 2 TB 5400 rpm HDD + Intel Optane Memory
1 x 3.5 inch HDD with M.2 Optane	3.5 500 GB 7200 rpm HDD + Intel Optane Memory
1 x 3.5 inch HDD with M.2 Optane	3.5 1 TB 7200 rpm HDD + Intel Optane Memory
1 x 3.5 inch HDD with M.2 Optane	3.5 2 TB 7200 rpm HDD + Intel Optane Memory

Audio

Table 7. Audio specifications

Features	Specifications
Controller	Realtek ALC3234
Type	Integrated
Speakers	Internal speaker (mono)
Interface	<ul style="list-style-type: none"> Headset port/Universal audio jack port (Front) Dell 2.0 Speaker System - AE215 (optional)

Features

Specifications

Internal speaker amplifier

- Dell 2.1 Speaker System - AE415 (optional)
- Dell AX210 USB Stereo speakers (optional)
- Dell Wireless 360 Speaker System - AE715 (optional)
- AC511 Sound Bar (optional)
- Dell Professional Sound Bar - AE515 (optional)
- Dell Stereo Soundbar - AX510 (optional)
- Dell Performance USB Headset - AE2 (optional)
- Dell Pro Stereo Headsets - UC150/UC350 (optional)

2 W (RMS) per channel

Video

Table 8. Video

Controller	Type	CPU Dependency	Graphics memory type	Capacity	External display support	Maximum resolution
Intel UHD Graphics 630	UMA	Intel Pentium Gold G5500T	Integrated	Shared system memory	DisplayPort 1.2 HDMI 1.4 DP/HDMI 2.0b/VGA (optional)	VGA: 2048x1536@60 Hz HDMI : 1920x1080@60 Hz
Intel UHD Graphics 610	UMA	Intel Celeron G4900T Intel Pentium Gold G5400T	Integrated	Shared system memory	DisplayPort 1.2 HDMI 1.4 DP/HDMI 2.0b/VGA (optional)	VGA: 2048x1536@60 Hz HDMI : 1920x1080@60 Hz
Intel HD Graphics 630	UMA	Intel Core i3-8100T Intel Core i3-8300T Intel Core i5-8400T Intel Core i5-8500T Intel Core i7-8700T	Integrated	Shared system memory	DisplayPort 1.2 HDMI 1.4 DP/HDMI 2.0b/VGA (optional)	VGA: 2048x1536@60 Hz HDMI : 1920x1080@60 Hz

Communications

Table 9. Communications

Features	Specifications
Network adapter	Realtek RTL8111HSD-CG Ethernet LAN 10/100/1000
Wireless	<ul style="list-style-type: none">Qualcomm QCA9377 Dual-band 1x1 802.11ac Wireless with MU-MIMO + Bluetooth 4.1; 2.4 Ghz - 5 Ghz.Qualcomm QCA61x4A Dual-band 2x2 802.11ac Wireless with MU-MIMO + Bluetooth 4.2; 2.4 Ghz - 5 Ghz.Intel Wireless-AC 9560, Dual-band 2x2 802.11ac Wi-Fi with MU-MIMO + Bluetooth 5; 2.4 Ghz - 5 Ghz.

Ports and connectors

Table 10. Ports and connectors

Feature	Specification
Memory card reader	SD 4.0 memory card reader (Optional)
USB	<ul style="list-style-type: none">Two USB 2.0 portsTwo USB 2.0 ports (supports Smart Power On)Four USB 3.1 Gen 1 ports
Security	Kensington lock slot
Audio	<ul style="list-style-type: none">Universal audio jackLine out port
Video	<ul style="list-style-type: none">DisplayPort 1.2HDMI 1.4 (UMA)DP/HDMI2.0b/VGA port (optional)
Network adapter	One RJ-45 connector
Serial port	One serial port (optional)
Parallel port	One parallel port (optional)

System board connectors

Table 11. System board connectors

Connector	Description
Serial ATA (SATA) connector	3 (2 ports Support Standard Rev 3.0, the rest of ports Support Standard Rev 2.0)
PCIe X16 slot	1 (Support Standard Rev 3.0)

Connector	Description
PCIe X1 slot	3

Power supply

Table 12. Power supply

Features	Specifications
Input Voltage	100-240 V, 1.6 A, 50-60 Hz
Input current (maximum)	<ul style="list-style-type: none"> • 260 W PSU (APFC Full range) (China only) • 260 W PSU (EPA Bronze) • 260 W PSU (EPA Platinum) (Brazil only) • 4.5 mm barrel type

Physical system dimensions

Table 13. Physical system dimensions

Features	Specifications
Chassis volume (liters)	14.77
Chassis weight (pounds / kilograms)	17.49/7.93

Table 14. Chassis dimensions

Features	Specifications
Height (inches / centimeters)	13.8/35
Width (inches / centimeters)	6.10/15.40
Depth (inches / centimeters)	10.80/27.40
Shipping weight (pounds / kilograms – includes packaging materials)	20.96/9.43

Table 15. Packaging parameters

Features	Specifications
Height (inches / centimeters)	13.19/33.50
Width (inches / centimeters)	19.40/49.40
Depth (inches / centimeters)	15.50/39.40

Security

Table 16. Security

Specifications	Optiplex 3060 Tower
Trusted Platform Module (TPM) 2.0 ¹	Integrated on system board
Cable Cover	Optional
Chassis Intrusion Switch	Optional
Dell Smartcard Keyboard	Optional
Chassis lock slot and loop support	Standard

¹TPM is not available in all countries.

Environmental

NOTE: For more details on Dell environmental features, please go to the environmental attributes section. See your specific region for availability.

Table 17. Environmental

Detail	Specifications
Energy efficient power supply	Optional
80 plus bronze certification	260 W EPA bronze
80 plus platinum certification	260 W EPA platinum
Customer replaceable unit	No
Recyclable packaging	Yes
MultiPack packaging	Optional, US only

System setup

System setup enables you to manage your desktop hardware and specify BIOS level options. From the System setup, you can:

- Change the NVRAM settings after you add or remove hardware
- View the system hardware configuration
- Enable or disable integrated devices
- Set performance and power management thresholds
- Manage your computer security

Topics:

- [System setup](#)
- [General options](#)
- [System information](#)
- [Video screen options](#)
- [Security](#)
- [Secure boot options](#)
- [Intel Software Guard Extensions options](#)
- [Performance](#)
- [Power management](#)
- [Post behavior](#)
- [Virtualization support](#)
- [Wireless options](#)
- [Maintenance](#)
- [System logs](#)
- [Advanced configuration](#)
- [SupportAssist System Resolution](#)

System setup

⚠ CAUTION: Unless you are an expert computer user, do not change the settings in the BIOS Setup program. Certain changes can make your computer work incorrectly.

📄 NOTE: Before you change BIOS Setup program, it is recommended that you write down the BIOS Setup program screen information for future reference.

Use the BIOS Setup program for the following purposes:

- Get information about the hardware installed in your computer, such as the amount of RAM and the size of the hard drive.
- Change the system configuration information.
- Set or change a user-selectable option, such as the user password, type of hard drive installed, and enabling or disabling base devices.

General options

Table 18. General

Option	Description
System Information	Displays the following information: <ul style="list-style-type: none">• System Information: Displays BIOS Version, Service Tag, Asset Tag, Ownership Tag, Ownership Date, Manufacture Date, and the Express Service Code.• Memory Information: Displays Memory Installed, Memory Available, Memory Speed, Memory Channel Mode, Memory Technology, DIMM 1 Size,, and DIMM 2 Size.• PCI Information: Displays Slot1, Slot2, Slot3, Slot4, Slot5_M.2, Slot6_M.2• Processor Information: Displays Processor Type, Core Count, Processor ID, Current Clock Speed, Minimum Clock Speed, Maximum Clock Speed, Processor L2 Cache, Processor L3 Cache, HT Capable, and 64-Bit Technology.• Device Information: Displays SATA-0, SATA 1, SATA 2, SATA 3, M.2 PCIe SSD-0, LOM MAC Address, Video Controller, Audio Controller, Wi-Fi Device, and Bluetooth Device.
Boot Sequence	Allows you to specify the order in which the computer attempts to find an operating system from the devices specified in this list.
Advanced Boot Options	Allows you to select the Enable Legacy Option ROMs option, when in UEFI boot mode. By default, this option is selected. <ul style="list-style-type: none">• Enable Legacy Option ROMs—Default• Enable Attempt Legacy Boot
UEFI Boot Path Security	This option controls whether or not the system will prompt the user to enter the Admin password when booting a UEFI boot path from the F12 Boot Menu. <ul style="list-style-type: none">• Always, Except Internal HDD—Default• Always• Never
Date/Time	Allows you to set the date and time settings. Changes to the system date and time take effect immediately.
.	.

System information

Table 19. System Configuration

Option	Description
Integrated NIC	Allows you to control the on-board LAN controller. The option 'Enable UEFI Network Stack' is not selected by default. The options are: <ul style="list-style-type: none">• Disabled• Enabled• Enabled w/PXE (default) <p> NOTE: Depending on the computer and its installed devices, the items listed in this section may or may not appear.</p>
Serial Port	Determines how the built-in serial port operates.

Option	Description
	<p>Choose any one option:</p> <ul style="list-style-type: none"> • Disabled • COM1 (selected by default) • COM2 • COM3 • COM4
SATA Operation	<p>Allows you to configure the operating mode of the integrated hard drive controller.</p> <ul style="list-style-type: none"> • Disabled = The SATA controllers are hidden • AHCI = SATA is configured for AHCI mode • RAID ON = SATA is configured to support RAID mode (selected by default)
Drives	<p>Allows you to enable or disable the various drives on-board:</p> <ul style="list-style-type: none"> • SATA-0 (enabled by default) • SATA-1 (enabled by default) • SATA-2 (enabled by default) • SATA-3 (enabled by default) • M.2 PCIe SSD-0 (enabled by default)
Smart Reporting	<p>This field controls whether hard drive errors for integrated drives are reported during system startup. The Enable Smart Reporting option is disabled by default.</p>
USB Configuration	<p>Allows you to enable or disable the integrated USB controller for:</p> <ul style="list-style-type: none"> • Enable USB Boot Support • Enable Front USB Ports • Enable Rear USB Ports <p>All the options are enabled by default.</p>
Front USB Configuration	<p>Allows you to enable or disable the front USB ports. All the ports are enabled by default.</p>
Rear USB Configuration	<p>Allows you to enable or disable the back USB ports. All the ports are enabled by default.</p>
USB PowerShare	<p>This option allows you to charge the external devices, such as mobile phones, music player. This option is disabled by default.</p>
Audio	<p>Allows you to enable or disable the integrated audio controller. The option Enable Audio is selected by default.</p> <ul style="list-style-type: none"> • Enable Microphone • Enable Internal Speaker <p>Both the options are selected by default.</p>
Dust Filter Maintenance	<p>Allows you to enable or disable BIOS messages for maintaining the optional dust filter installed in your computer. BIOS will generate a pre-boot reminder to clean or replace the dust filter based on the interval set. The option Disabled is selected by default.</p> <ul style="list-style-type: none"> • Disabled • 15 days • 30 days • 60 days • 90 days • 120 days • 150 days

Option	Description
	<ul style="list-style-type: none"> 180 days
Miscellaneous Devices	<p>Allows you to enable or disable various on board devices.. The option Enable Secure Digital (SD) Card is selected by default.</p> <ul style="list-style-type: none"> Enable Secure Digital (SD) Card Secure Digital (SD) Card Boot Secure Digital (SD) Card Read-Only Mode

Video screen options

Table 20. Video

Option	Description
Primary Display	<p>Allows you to select the primary display when multiple controllers are available in the system.</p> <ul style="list-style-type: none"> Auto (default) Intel HD Graphics <p>NOTE: If you do not select Auto, the on-board graphics device will be present and enabled.</p>

Security

Table 21. Security

Option	Description
Admin Password	Allows you to set, change, and delete the admin password.
System Password	Allows you to set, change, and delete the system password.
Internal HDD-0 Password	Allows you to set, change, and delete the computer's internal HDD.
Strong Password	This option lets you enable or disable strong passwords for the system.
Password Configuration	Allows you to control the minimum and maximum number of characters allowed for a administrative password and the system password. The range of characters is between 4 and 32.
Password Bypass	<p>This option lets you bypass the System (Boot) Password and the internal HDD password prompts during a system restart.</p> <ul style="list-style-type: none"> Disabled — Always prompt for the system and internal HDD password when they are set. This option is disabled by default. Reboot Bypass — Bypass the password prompts on Restarts (warm boots). <p>NOTE: The system will always prompt for the system and internal HDD passwords when powered on from the off state (a cold boot). Also, the system will always prompt for passwords on any module bay HDDs that may be present.</p>
Password Change	<p>This option lets you determine whether changes to the System and Hard Disk passwords are permitted when an administrator password is set.</p> <p>Allow Non-Admin Password Changes - This option is enabled by default.</p>
UEFI Capsule Firmware Updates	This option controls whether this system allows BIOS updates via UEFI capsule update packages. This option is selected by default. Disabling this option will block BIOS updates from services such as Microsoft Windows Update and Linux Vendor Firmware Service (LVFS)
TPM 2.0 Security	Allows you to control whether the Trusted Platform Module (TPM) is visible to the operating system.

Option	Description
	<ul style="list-style-type: none"> TPM On (default) Clear PPI Bypass for Enable Commands PPI Bypass for Disable Commands PPI Bypass for Clear Commands Attestation Enable (default) Key Storage Enable (default) SHA-256 (default) <p>Choose any one option:</p> <ul style="list-style-type: none"> Disabled Enabled (default)
Computrace	<p>This field lets you Activate or Disable the BIOS module interface of the optional Computrace Service from Absolute Software. Enables or disables the optional Computrace service designed for asset management.</p> <ul style="list-style-type: none"> Deactivate Disable Activate - This option is selected by default.
Chassis Intrusion	<p>This field controls the chassis intrusion feature.</p> <p>Choose any one of the option:</p> <ul style="list-style-type: none"> Disabled (default) Enabled On-Silent
Admin Setup Lockout	<p>Allows you to prevent users from entering Setup when Admin password is set. This option is not set by default.</p>
Master Password Lockout	<p>Allows you to disable master password support Hard Disk passwords need to be cleared before the settings can be changed. This option is not set by default.</p>
SMM Security Mitigation	<p>Allows you to enable or disable additional UEFI SMM Security Mitigation protections. This option is not set by default.</p>

Secure boot options

Table 22. Secure Boot

Option	Description
Secure Boot Enable	<p>Allows you to enable or disable Secure Boot feature</p> <ul style="list-style-type: none"> Secure Boot Enable <p>This option is not selected by default.</p>
Secure Boot Mode	<p>Allows you to modify the behavior of Secure Boot to allow evaluation or enforcement of UEFI driver signatures.</p> <ul style="list-style-type: none"> Deployed Mode (default) Audit Mode
Expert key Management	<p>Allows you to manipulate the security key databases only if the system is in Custom Mode. The Enable Custom Mode option is disabled by default. The options are:</p>

Option	Description
	<ul style="list-style-type: none"> PK (default) KEK db dbx <p>If you enable the Custom Mode, the relevant options for PK, KEK, db, and dbx appear. The options are:</p> <ul style="list-style-type: none"> Save to File- Saves the key to a user-selected file Replace from File- Replaces the current key with a key from a user-selected file Append from File- Adds a key to the current database from a user-selected file Delete- Deletes the selected key Reset All Keys- Resets to default setting Delete All Keys- Deletes all the keys <p>NOTE: If you disable the Custom Mode, all the changes made will be erased and the keys will restore to default settings.</p>

Intel Software Guard Extensions options

Table 23. Intel Software Guard Extensions

Option	Description
Intel SGX Enable	<p>This field specifies you to provide a secured environment for running code/storing sensitive information in the context of the main OS.</p> <p>Click one of the following options:</p> <ul style="list-style-type: none"> Disabled Enabled Software controlled—Default
Enclave Memory Size	<p>This option sets SGX Enclave Reserve Memory Size</p> <p>Click one of the following options:</p> <ul style="list-style-type: none"> 32 MB 64 MB 128 MB—Default

Performance

Table 24. Performance

Option	Description
Multi Core Support	<p>This field specifies whether the process has one or all cores enabled. The performance of some applications improves with the additional cores.</p> <ul style="list-style-type: none"> All—Default 1 2

Option	Description
	<ul style="list-style-type: none"> • 3
Intel SpeedStep	<p>Allows you to enable or disable the Intel SpeedStep mode of processor.</p> <ul style="list-style-type: none"> • Enable Intel SpeedStep <p>This option is set by default.</p>
C-States Control	<p>Allows you to enable or disable the additional processor sleep states.</p> <ul style="list-style-type: none"> • C states <p>This option is set by default.</p>
Intel TurboBoost	<p>Allows you to enable or disable the Intel TurboBoost mode of the processor.</p> <ul style="list-style-type: none"> • Enable Intel TurboBoost <p>This option is set by default.</p>
Hyper-Thread Control	<p>Allows you to enable or disable the HyperThreading in the processor.</p> <ul style="list-style-type: none"> • Disabled • Enabled—Default

Power management

Table 25. Power Management

Option	Description
AC Recovery	<p>Determines how the system responds when AC power is re-applied after a power loss. You can set the AC Recovery to:</p> <ul style="list-style-type: none"> • Power Off • Power On • Last Power State <p>This option is Power Off by default.</p>
Enable Intel Speed Shift Technology	<p>Allows you to enable or disable Intel Speed Shift Technology support. The option Enable Intel Speed Shift Technology is set by default.</p>
Auto On Time	<p>Sets time to automatically turn on the computer. Time is kept in standard 12-hour format (hour:minutes:seconds). Change the startup time by typing the values in the time and AM/PM fields.</p> <p>i NOTE: This feature does not work if you turn off your computer using the switch on a power strip or surge protector or if Auto Power is set to disabled.</p>
Deep Sleep Control	<p>Allows you to define the controls when Deep Sleep is enabled.</p> <ul style="list-style-type: none"> • Disabled • Enabled in S5 only • Enabled in S4 and S5 <p>Disabled (by default).</p>

Option	Description
Fan Control Override	This field determines the speed of the fan. When enabled the system fan runs at full speed. This option is disabled by default.
USB Wake Support	Allows you to enable the USB devices to wake the computer from standby mode. The option "Enable USB Wake Support" is selected by default
Wake on LAN/WWAN	<p>This option allows the computer to power up from the off state when triggered by a special LAN signal. This feature only works when the computer is connected to AC power supply.</p> <ul style="list-style-type: none"> • Disabled - Does not allow the system to power on by special LAN signals when it receives a wake-up signal from the LAN or wireless LAN. • LAN or WLAN - Allows the system to be powered on by special LAN or wireless LAN signals. • LAN Only - Allows the system to be powered on by special LAN signals. • LAN with PXE Boot - A wakeup packet sent to the system in either the S4 or S5 state, that will cause the system to wake-up and immediately boot to PXE. • WLAN Only - Allows the system to be powered on by special WLAN signals. <p>This option is Disabled by default.</p>
Block Sleep	Allows you to block entering to sleep (S3 state) in OS environment. This option is disabled by default.

Post behavior

Table 26. POST Behavior

Option	Description
Numlock LED	Allows you to enable or disable the Numlock feature when your computer starts. This option is enabled by default.
Keyboard Errors	Allows you to enable or disable the keyboard error reporting when the computer starts. The option Enable Keyboard Error Detection is enabled by default.
Fast Boot	<p>This option can speed up the boot process by bypassing some compatibility steps:</p> <ul style="list-style-type: none"> • Minimal — The system boots quickly, unless the BIOS has been updated, memory changed, or the previous POST did not complete. • Thorough — The system does not skip any steps in the boot process. • Auto — This allows the operating system to control this setting (this works only when the operating system supports Simple Boot Flag). <p>This option is set to Thorough by default.</p>
Extend BIOS POST Time	<p>This option creates an additional pre-boot delay.</p> <ul style="list-style-type: none"> • 0 seconds (default) • 5 seconds • 10 seconds
Full Screen Logo	This option will display full screen logo if your image match screen resolution. The option Enable Full Screen Logo is not set by default.
Warnings and Errors	<p>This option causes the boot process to only pause when warning or errors are detected. Choose any one of the option:</p> <ul style="list-style-type: none"> • Prompt on Warnings and Errors • Continue on Warnings • Continue on Warnings and Errors

Virtualization support

Table 27. Virtualization Support

Option	Description
Virtualization	<p>This option specifies whether a Virtual Machine Monitor (VMM) can utilize the additional hardware capabilities provided by the Intel Virtualization technology.</p> <ul style="list-style-type: none">• Enable Intel Virtualization Technology <p>This option is set by default.</p>
VT for Direct I/O	<p>Enables or disables the Virtual Machine Monitor (VMM) from utilizing the additional hardware capabilities provided by the Intel Virtualization technology for direct I/O.</p> <ul style="list-style-type: none">• Enable VT for Direct I/O <p>This option is set by default.</p>

Wireless options

Table 28. Wireless

Option	Description
Wireless Device Enable	<p>Allows you to enable or disable the internal wireless devices.</p> <p>The options are:</p> <ul style="list-style-type: none">• WLAN/WiGig• Bluetooth <p>All the options are enabled by default.</p>

Maintenance

Table 29. Maintenance

Option	Description
Service Tag	<p>Displays the service tag of your computer.</p>
Asset Tag	<p>Allows you to create a system asset tag if an asset tag is not already set.</p> <p>This option is not set by default.</p>
SERR Messages	<p>Controls the SERR message mechanism. This option is set by default. Some graphics cards require that the SERR message mechanism be disabled.</p>
BIOS Downgrade	<p>Allows you to flash previous revisions of the system firmware.</p> <ul style="list-style-type: none">• Allow BIOS Downgrade <p>This option is set by default.</p>

Option	Description
Bios Recovery	<p>BIOS Recovery from Hard Drive—This option is set by default. Allows you to recover the corrupted BIOS from a recovery file on the HDD or an external USB key.</p> <p>BIOS Auto-Recovery— Allows you to recover the BIOS automatically.</p> <p> NOTE: BIOS Recovery from Hard Drive field should be enabled.</p> <p>Always Perform Integrity Check—Performs integrity check on every boot.</p>
First Power On Date	Allows you the set Ownership date. The option Set Ownership Date is not set by default.

System logs

Table 30. System Logs

Option	Description
BIOS events	Allows you to view and clear the System Setup (BIOS) POST events.

Advanced configuration

Table 31. Advanced configuration

Option	Description
ASPM	<p>Allows you to set the ASPM level.</p> <ul style="list-style-type: none"> Auto (default) - There is handshaking between the device and PCI Express hub to determine the best ASPM mode supported by the device Disabled - ASPM power management is turned off at all time L1 Only - ASPM power management is set to use L1

SupportAssist System Resolution

Option	Description
Auto OS Recovery Threshold	<p>Allows you to control the automatic boot flow for SupportAssist System. Options are:</p> <ul style="list-style-type: none"> Off 1 2 (Enabled by default) 3
SupportAssist OS Recovery	Allows you to recover the SupportAssist OS Recovery (Disabled by default)

Software

This chapter details the supported operating systems along with instructions on how to install the drivers.

Topics:

- [Supported operating systems](#)
- [Downloading drivers](#)
- [Network adapter drivers](#)
- [Audio drivers](#)
- [Display adapter](#)
- [Security drivers](#)
- [Storage controller](#)
- [System device drivers](#)
- [Other device drivers](#)

Supported operating systems

Table 32. Supported operating systems

Supported operating systems	Description
Windows operating system	<ul style="list-style-type: none"> • Microsoft Windows 10 Home (64-bit) • Microsoft Windows 10 Pro (64-bit) • Microsoft Windows 10 Pro National Academic (64-bit) • Microsoft Windows 10 Home National Academic (64-bit)
Other	<ul style="list-style-type: none"> • Ubuntu 16.04 SP1 LTS (64-bit) • Neokylin v6.0 SP4 (China only)

Downloading drivers

- 1 Turn on the desktop.
- 2 Go to **Dell.com/support**.
- 3 Click **Product Support**, enter the Service Tag of your desktop, and then click **Submit**.

NOTE: If you do not have the Service Tag, use the auto detect feature or manually browse for your desktop model.

- 4 Click **Drivers and Downloads**.
- 5 Select the operating system installed on your desktop.
- 6 Scroll down the page and select the driver to install.
- 7 Click **Download File** to download the driver for your desktop.
- 8 After the download is complete, navigate to the folder where you saved the driver file.
- 9 Double-click the driver file icon and follow the instructions on the screen.

Network adapter drivers

Verify if the Network adapter drivers are already installed in the system.

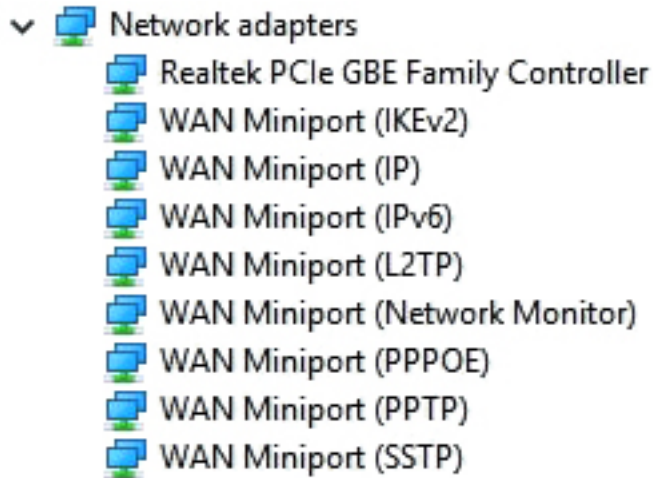

Audio drivers

Verify if the audio drivers are already installed in the computer.

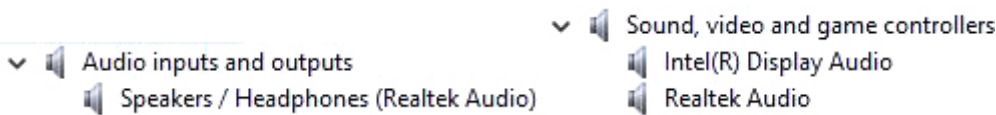

Display adapter

Verify if the display adapter drivers are already installed in the system.

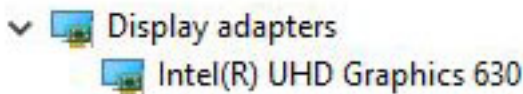



Security drivers

Verify if the security drivers are already installed in the system.



Storage controller

Verify if the storage control drivers are already installed in the system.

- ▼  Storage controllers
 -  Intel(R) Chipset SATA/PCIe RST Premium Controller
 -  Microsoft Storage Spaces Controller

System device drivers



Verify if the system device drivers are already installed in the system.

- ▼ System devices
 - ACPI Fan
 - ACPI Fan
 - ACPI Fan
 - ACPI Fan
 - ACPI Fan
 - ACPI Fixed Feature Button
 - ACPI Power Button
 - ACPI Processor Aggregator
 - ACPI Thermal Zone
 - CannonLake LPC Controller (H370) - A304
 - CannonLake PCI Express Root Port #5 - A33C
 - CannonLake PCI Express Root Port #6 - A33D
 - CannonLake SMBus - A323
 - CannonLake SPI (flash) Controller - A324
 - CannonLake Thermal Subsystem - A379
 - Composite Bus Enumerator
 - Dell Diag Control Device
 - Dell System Analyzer Control Device
 - High Definition Audio Controller
 - High precision event timer
 - Intel(R) Management Engine Interface
 - Intel(R) Power Engine Plug-in
 - Intel(R) Xeon(R) E3 - 1200/1500 v5/6th Gen Intel(R) Core(TM) Gaussian Mixture Model - 1911
 - Microsoft ACPI-Compliant System
 - Microsoft System Management BIOS Driver
 - Microsoft UEFI-Compliant System
 - Microsoft Virtual Drive Enumerator
 - Microsoft Windows Management Interface for ACPI
 - Microsoft Windows Management Interface for ACPI
 - Microsoft Windows Management Interface for ACPI
 - NDIS Virtual Network Adapter Enumerator
 - Numeric data processor
 - PCI Express Root Complex
 - PCI standard host CPU bridge
 - PCI standard RAM Controller
 - Plug and Play Software Device Enumerator
 - Programmable interrupt controller
 - Remote Desktop Device Redirector Bus
 - System CMOS/real time clock
 - System timer
 - UMBus Root Bus Enumerator



Other device drivers

Verify if the following drivers are already installed in the system.



Universal Serial Bus Controller

- ▼  Universal Serial Bus controllers
 -  Intel(R) USB 3.1 eXtensible Host Controller - 1.10 (Microsoft)
 -  USB Root Hub (USB 3.0)



Software components

- ▼  Software devices
 -  Microsoft GS Wavetable Synth
 -  Microsoft RRAS Root Enumerator



Ports (COM and LPT)

- ▼  Ports (COM & LPT)
 -  Communications Port (COM1)

Mice and other pointing devices

- ▼  Mice and other pointing devices
 -  HID-compliant mouse

Firmware

- ▼  Firmware
 -  System Firmware

Getting help

Contacting Dell

① **NOTE:** If you do not have an active Internet connection, you can find contact information on your purchase invoice, packing slip, bill, or Dell product catalog.

Dell provides several online and telephone-based support and service options. Availability varies by country and product, and some services may not be available in your area. To contact Dell for sales, technical support, or customer service issues:

- 1 Go to **Dell.com/support**.
- 2 Select your support category.
- 3 Verify your country or region in the **Choose a Country/Region** drop-down list at the bottom of the page.
- 4 Select the appropriate service or support link based on your need.