

Quick Installation Guide

AC1200/1900 Wireless Dual Band Gigabit Access Point

EAP320 / EAP330

7106505995 REV1.0.0

1 Network Topology Requirement

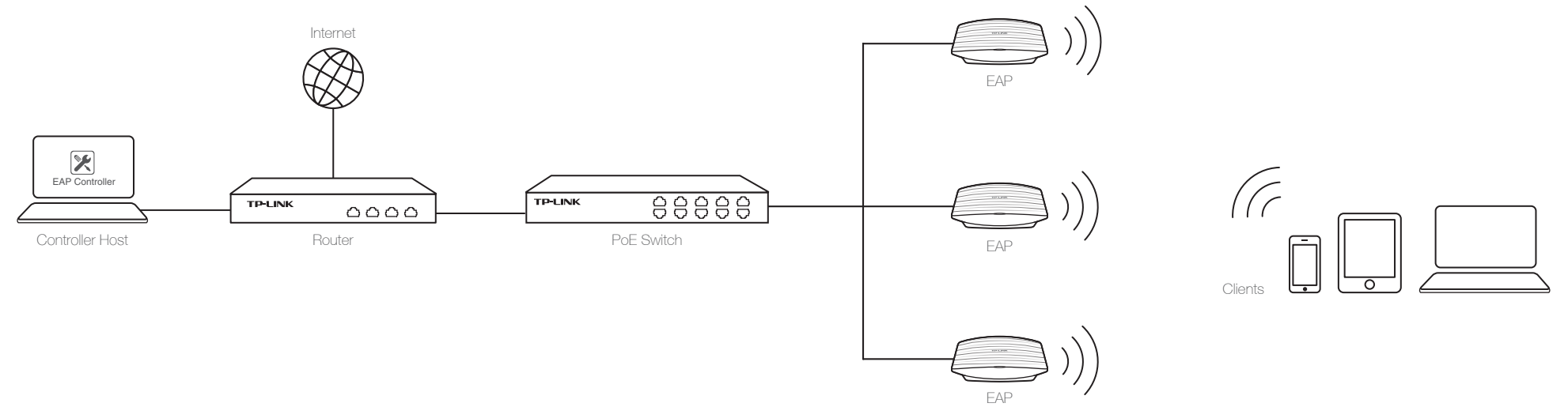

- A DHCP server (typically a router) is required to assign IP addresses to the EAP and clients in your local network.
- A computer running the EAP Controller software can locate in the same or different subnet with the EAPs.

2 Hardware Overview

LED Indication

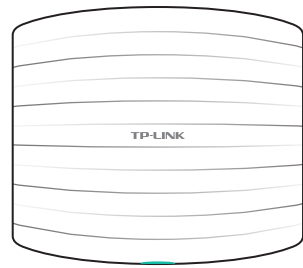

- | | | | |
|--|--|--|--|
| | Solid green
The device is working properly. | | Flashing yellow
Firmware update is in progress. Do not disconnect or power off the device. |
| | Flashing red
System errors. RAM, Flash, Ethernet, WLAN or firmware may be malfunctioning. | | Double-flashing red, green, yellow
The device is being reset to its factory default settings. |

Interface Panel

EAP320

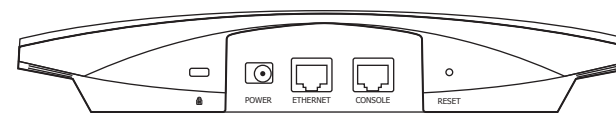

EAP330

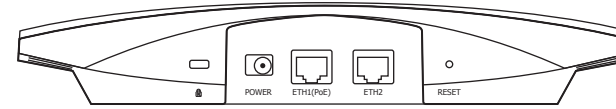

NOTE:

With the device powered on, press and hold the **RESET** button for about 8 seconds until the LED flashes red, then release the button. The device will restore to factory default settings.

ETHERNET of EAP320 and **ETH1 (PoE)** of EAP330 is to connect to a router or a switch to transmit data or to a PSE (Power Sourcing Equipment), such as a PoE switch, for both data transmission and Power over Ethernet (PoE) through Ethernet cabling. **ETH1** and **ETH2** can be combined together to double the network backhaul capacity. **CONSOLE** is used to connect to the serial port of a computer or a terminal to check and monitor system information of the EAP device. CLI commands are not available in current software version. We will release a new version supporting CLI commands soon. Please pay close attention to our official website.

3 Hardware Installation

The EAP can be ceiling rail mounted, ceiling-mounted, and wall-mounted. The instructions for various mounting options are on the back of this Quick Installation Guide.

Option 1: Ceiling Rail Mounting

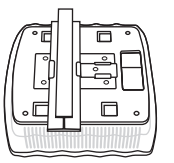

Option 2: Ceiling Mounting

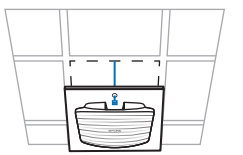

Option 3: Wall Mounting

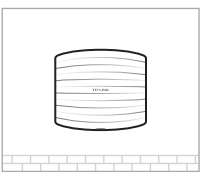

4 Power Supply

EAP can be powered via a PSE device (such as a PoE switch) or a power adapter.

Via PoE Switch

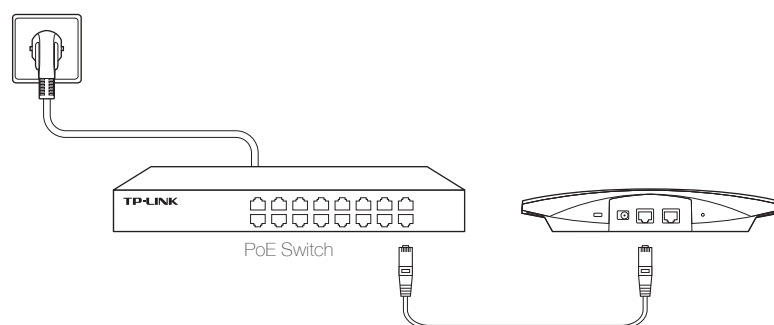

Connect the Ethernet cable from the PoE switch to the ETHERNET port.

Via Power Adapter

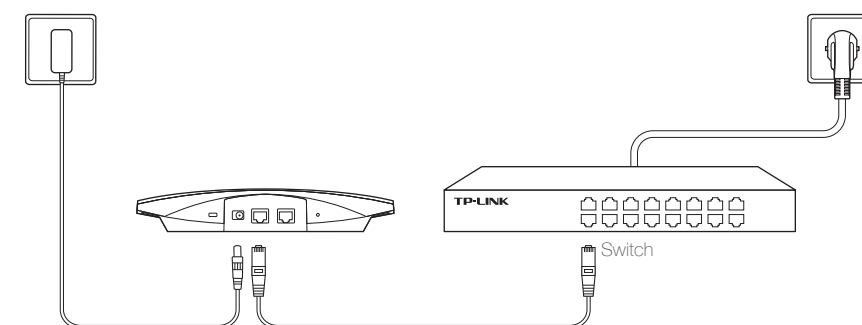

Plug one end of the provided power adapter into the POWER port of the EAP and the other end to a standard electrical wall outlet.

5 Software Configuration

To quickly set up a wireless network connection with mass EAPs, please follow the steps below. Note: The IP address of the management computer must be reachable for the EAPs in the network.

Step 1: Installing the EAP Controller

Find the **EAP Controller** application file (for Windows user only) from our website at www.tp-link.com. Run the file and follow the wizard to install the **EAP Controller** on the computer.

Step 2: Configuring the EAP Controller

Launch the **EAP Controller** and follow the configuration wizard to create a primary wireless network. After the wizard is finished, a login screen will appear. Enter the admin name and password you created and click Sign In.

Step 3: Adopting the EAP devices

Adopt the EAP devices in the Controller management interface to change the status from pending to connected.

[For More Configurations](#)

Now you can manage your wireless network and view network statistic using the EAP Controller. Please refer to the *EAP Controller User Guide* to learn more information on configuring and using the Controller software.

Option 1: Ceiling Rail Mounting

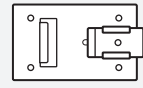

Ceiling T-rail Clip



M3x6 Pan-head Screws
(Qty.5)

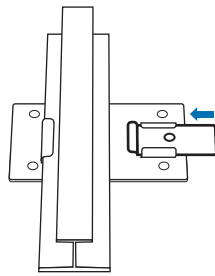

- 1 Position the Ceiling T-rail Clip and push the movable part toward the rail base.

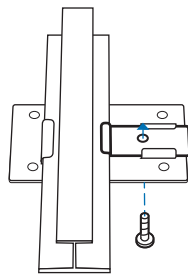

- 2 Use an M3x6 pan-head screw to secure the T-rail Clip onto the ceiling rail.

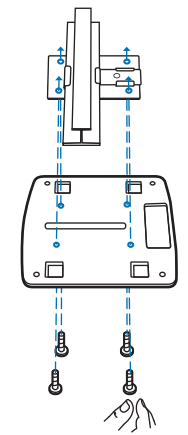

- 3 Attach the mounting bracket to the Ceiling T-rail Clip using four M3x6 pan-head screws.

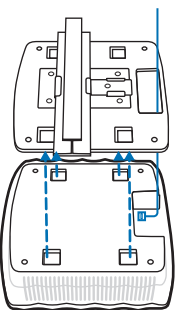

- 4 Make the Ethernet Cable pass through the fixing hole of the mounting bracket. Connect the cable to the ETHERNET port and attach the EAP to the bracket.

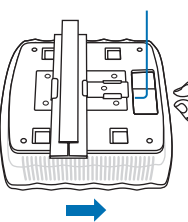

- 5 Push the EAP along the direction of arrows until it locks into place, as shown on the left. Then adjust the cable to make the exposed part hidden behind the EAP.

Option 2: Ceiling Mounting



Washers
(Qty.4)



M3x30 Pan-head Screws
(Qty.4)



Wing Nuts
(Qty.4)

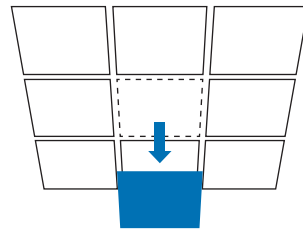

- 1 Remove the ceiling tile.

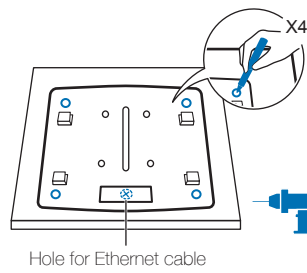

Hole for Ethernet cable

- 2 Place the mounting bracket in the center of the ceiling tile. Mark the four positions of the screw holes and a hole for the Ethernet cable to feed through. Drill four 4mm holes for the screws and a 10mm hole for the Ethernet cable.

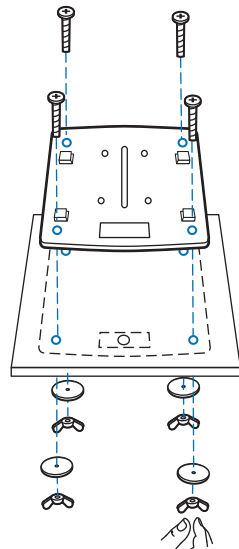

- 3 Secure the mounting bracket to the ceiling tile using four M3x30 pan-head screws, washers and wing nuts.

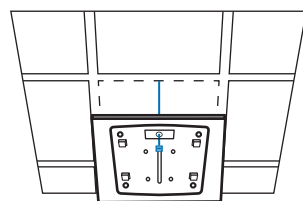

- 4 Feed the Ethernet cable through the hole. Then set the ceiling tile back into place.

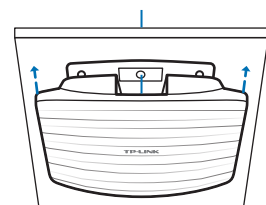

- 5 Connect the Ethernet cable to the ETHERNET port and push the EAP along the direction of arrows until it locks into place, as shown on the left. Then adjust the cable to make the exposed part hidden behind the EAP.

Option 3: Wall Mounting

Note: We do not recommend you to install the EAP with the Ethernet port upward.



M3x28 Plastic Wall Anchors
(Qty.4)



M3x20 Self-tapping Screws
(Qty.4)

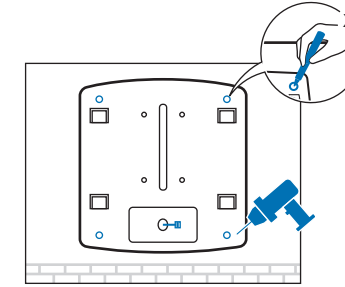

- 1 If your Ethernet cable feeds through the wall, you can position the mounting bracket to make the cable through the fixing hole. Mark the four positions of the screw holes and then drill four 6mm holes.

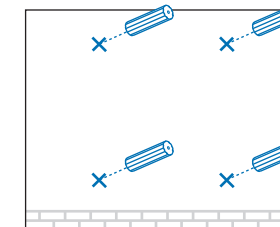

- 2 Insert the plastic wall anchors into the 6mm holes.

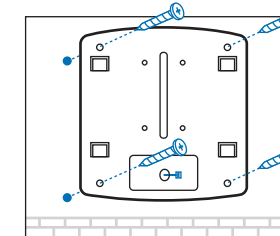

- 3 Secure the mounting bracket to the wall by driving the self-tapping screws into the anchors. Make sure that the shoulders of the mounting bracket are on the outside.

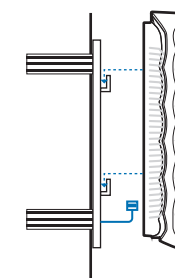

- 4 Connect the Ethernet cable to the ETHERNET port on the EAP and attach the EAP to the mounting bracket, as shown on the left.

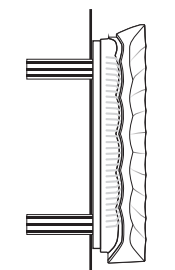

- 5 Push the EAP along the direction of arrows until it locks into place, and then adjust the cable to make the exposed part hidden behind the EAP.